

SSN-04

CONTROL SYSTEM FOR ROLLER SHUTTER MOTORS

User Manual

General

SSN-04 control system is safe to use and install if all the guidelines in this manual are met and relevant safety and accident prevention regulations are adhered to.

All installation and repairs must be carried out by a trained and qualified professional.

Do not modify the control system in any way. All warranty repairs must be performed by the manufacturer. Use genuine spare parts and accessories only.

The operation safety can be guaranteed if used as intended and if the limits are not exceeded.

Other safety rules

Follow relevant safety and accident prevention rules during installation, start-up and maintenance. The following regulations require special attention:

1. *Fire regulations*

2. *Accident prevention regulations*

GENERAL INFORMATION ON HAZARDS AND SAFETY MEASURES

The following are the general rules on using INEL controls with other devices which must be adhered to when installing and using the devices.



Caution - Damage to control system or other equipment may occur if no precautions are taken.



- Check all screw connections before installing the control system.
- ***Danger - Life and health hazard may occur if no precautions are taken.***
- Adhere to the safety and accident prevention rules for specific use (e.g. doors, roller shutters).
- Disconnect power cables before replacing the fuses.
- Install all the required safety and protective devices when installing the control system.
- For INEL devices with continuous control voltage supply, besides fuse protection, use a switch providing safe voltage break (e.g. fuse switch) and easy disconnection.
- Periodically check all cables and conductors for insulation damage and breaks.
- Disconnect power supply before replacing damaged cables.
- Check available and permissible voltage before connecting the device.

WARNING – PERSONNEL SAFETY:

- do not allow children to play with the devices;
- keep the devices out of reach of children;
- do not allow anyone near the device until the open/close procedure is completed;
- train and instruct users on operation and hazards specific to the device. The person is deemed authorised if the employer, administrator or owner gave them permission to operate the roller shutter and provided all instructions regarding its use.

Control system operation and maintenance.

Please adhere to the following rules to ensure that all the requirements for SNN-04 control system components are met and ensure long term, failure-free operation.

- **Protect system components from humidity. Precipitation, high humidity and liquids containing mineral compounds may cause corrosion in electronic components.**
- **Do not use and store the devices in dirty and dusty places (plaster, gypsum plaster etc.). It may result in damage to movable system components.**
- **Do not use the devices at low temperatures (no heating). The devices tend to heat up during operation and the humidity tends to accumulate inside, which may result in damage to electronic components.**
- **Protect system components from high temperatures. High temperature reduces the service life of electronic components and may cause deformation and melting of plastic components.**
- **Do not drop or throw the device and avoid mechanical damage. Careless handling may result in damage to electronic components.**
- **Protect system components from third party interference (workers, unauthorised electronics engineers).**
- **Do not misuse or excessively use the device. Do not repair or modify. The device can only be repaired by the company which installed the device and issued the warranty.**
- **Do not use any corrosive substances, solvents or strong detergents to clean the device. Wipe with a soft cloth and mild detergent.**
- **In case of any failures or defects, notify the company responsible for control system installation immediately. The company will provide help in troubleshooting and repairs.**
- **Failure to observe the guidelines will void the warranty!**

The control system is intended for operation of roller shutter in any configuration

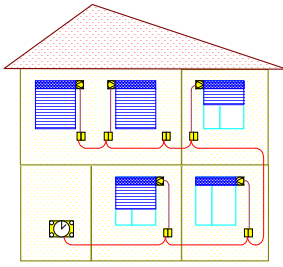

System description

The system can be used in many different configurations, depending on individual user requirements and conditions. The following rule applies to any configuration: each motor requires a single ST-01 controller.

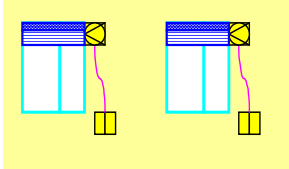

A single **ST-01** controller opens and closes a single roller shutter. Press \uparrow to open and \downarrow to close the roller shutter. The roller shutter moves until it reaches its fully open or closed position. Press any key during roller shutter movement to stop any time (*Comfort* function).

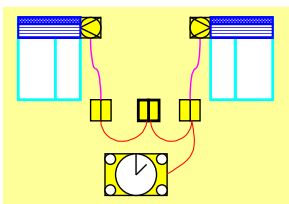

ST-02 group controller controls individual **ST-01** controllers with a single manual switch.

A group of roller shutters (elevations, levels or rooms) is defined via the central control unit and can be operated with a single switch. **NOTE:** In its previous version, the central control unit was not required to configure the **ST-02** group controller, whereas in its current version, **CR-02** central control unit is required.

CR-02 central control unit allows local (keypad) or remote (remote control) operation of individual or predefined groups of roller shutters. The central control unit allows automatic opening and closing of individual or groups of roller shutters at pre-set day and time.

SYMBOLS

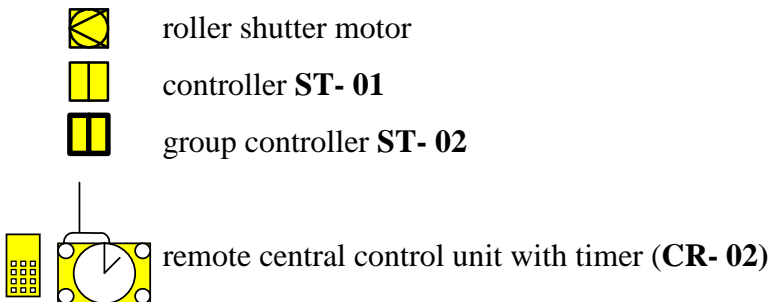

ST-01 Controller

Cables connected to ST - 01 can be classified into three categories

1. Power supply cable

- supply voltage 230 VAC cable 1 - connector **G1-1**
- supply voltage 230 VAC cable 2 - connector **G1-2**

2. Motor supply cables

- cable up – connector **G2 - 5**
- cable common – connector **G2 - 4**
- cable down – connector **G2 - 3**

2. Signal cables - connection between the controller and central control unit

- control cable – connector **GN02 - WEJ (INPUT)**
- weight – connector **GN02 - GND (EARTH)**

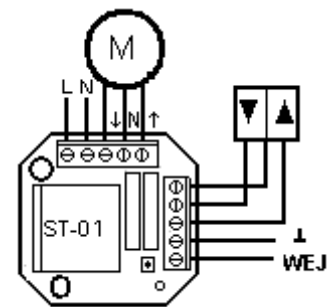

ST - 02 GROUP CONTROLLER

ST - 02 connectors can be classified into three categories

1. Supply connector

- supply voltage 230 VAC cable 1 – connector **G1-L (PHASE)**
- supply voltage 230 VAC cable 2 – connector **G1-N (NEUTRAL)**

2. Signal connector - connection between the controller and central control unit

- control cable – connector **GN02 - WYJ (OUTPUT)**
- weight – connector **GN02 - GND (EARTH)**

3. Manual switch connector X2 (for connecting the central alarm control panel - voltage free contact)

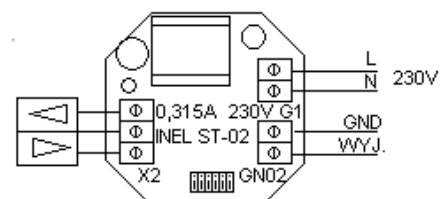

Recommended wiring guidelines

1. The electrical system can be designed and installed by an authorised person only.
2. Adhere to the relevant legal requirements.
3. 230 V connector cross-section: 1.5 mm²
4. Control bus connector cross-section: 0.5 mm²

Note:

All double depth 60 mm back boxes for ST-01 and ST-02 controller installation require stranded conductors with the following cross-sections.

CENTRAL CONTROL UNIT WITH TIMER (CR-02)

The central control unit is connected to the mains and features 230V AC power supply connector (G4) and control bus connector (G1):

- signal cable to connector **G1-1**
- earth to connector **G1-2**

WIRING DIAGRAM

Three cables between each ST-01 and corresponding motor – motor power supply

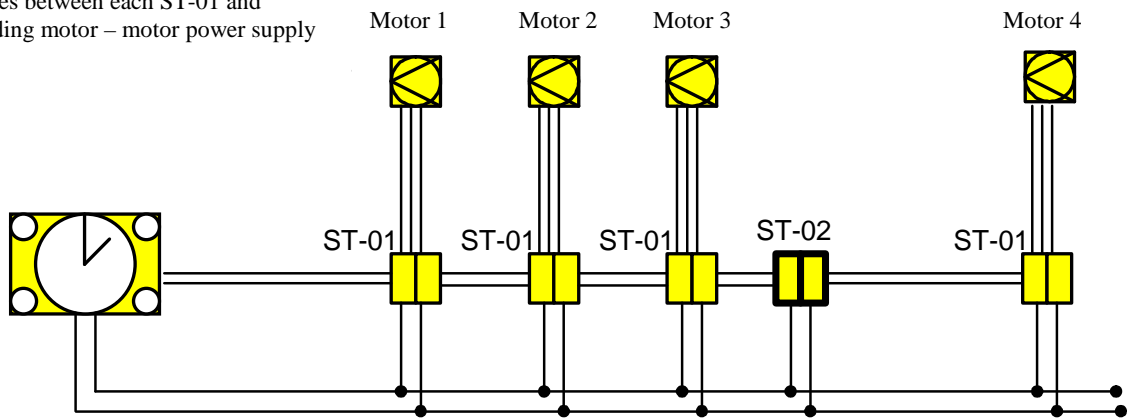

230 VAC to each device – controller power supply

Detailed ST-01 and ST-02 controller wiring diagram

The diagram shows a method of connecting individual devices. ST-01 and ST-02 controllers are flush mounted in the double depth back boxes and supplied with 230 VAC. Each back box requires mains connection. ST-01 controller back box requires motor supply cable connection. Connect two-conductor cables between all back boxes (ST-01 and ST-02 controller) and from any back box to the central control unit installation location. The wiring will allow system installation.

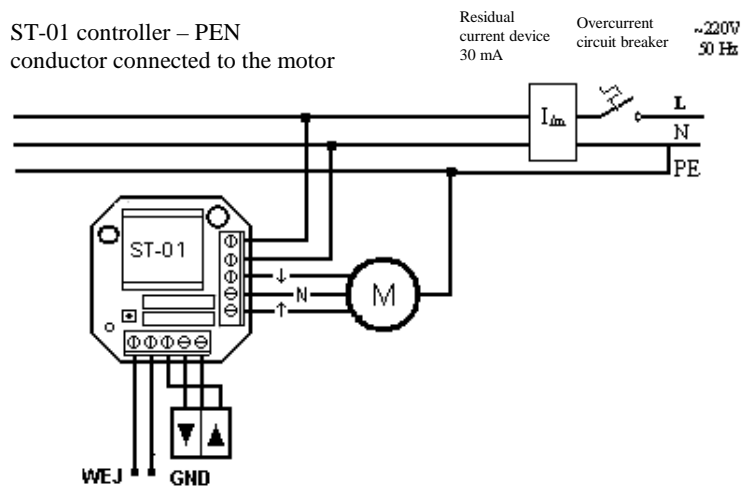

SSN-04 SYSTEM CONFIGURATION

A unique number must be assigned to each individual roller shutter to enable remote control. Control system configuration requires to assign each individual ST-01 controller a unique number. The numbers correspond to remote control commands. A roller shutter connected to ST-01 controller no. 3 will respond to any commands issued by pressing button '3'. The second stage requires to define a motor group, i.e. determine which motor is assigned to which group and to program ST-02 controller, i.e. assign a group number to the controller.

SETTING ST-01 CONTROLLER NUMBER

The number can be set manually, via PIL-99GS remote control or CR-02 central control unit.

Setting ST-01 controller number manually.

Press and hold LEARN button. The controller will switch to manual setting mode after approx. 5 seconds (indicated by green LED). Release LEARN button. To set the number from 10> press LEARN button to select the number of tens required (green LED indicates number of tens from 10 to 60). Each press of the button is indicated with a short blink. The interval between each press of the button may not exceed 3 seconds. If no button is pressed for approx. 5 seconds, the controller will switch to number setting mode (indicated by red LED). Press LEARN button to select the number of ones required (red LED indicates number of ones selected from 1 to 9). Each press of the button is indicated with a short blink.

The interval between each press of the button may not exceed 3 seconds. If no button is pressed for approx. 5 seconds, the controller will exit the setting mode. The number is confirmed by LED blinking.

Example 1: To assign number '45', press and hold LEARN button until the current controller number is displayed and the green LED is turned on. Release LEARN button and press again 4 times. Wait for the red LED to turn on and press LEARN button 5 times. Wait for the red LED to turn off. The number is confirmed by LED blinking.

Example 2: To assign number '06', press and hold LEARN button until the current controller number is displayed and the green LED is turned on. Release LEARN button, wait for the red LED to turn on and press LEARN button 6 times. Wait for the red LED to turn off. The number is confirmed by LED blinking.

Setting ST-01 controller number on PIL-99 remote control and CR-02 central control unit

Press LEARN button on ST-01A controller. The current controller number is displayed and the controller switches to LEARN mode for approx. 10 seconds. If another number is selected on the remote control or central control unit, the controller in learn mode will store the selected number. The number is confirmed by LED blinking. If there is no signal within 10 seconds, the controller exits the learn mode indicating no change in number with LED blinking. If no remote control is available (CR-02 central control unit), help of another user may be required.

Example 1: To assign number '19', press and hold LEARN button until the current controller number is displayed and the red LED is turned on. Select '19' on the remote control/central control unit and press up or down. The code is accepted and the number is displayed (green LED flashes once and red LED flashes nine times).

Example 2: To assign number '04', press and hold LEARN button until the current controller number is displayed and the red LED is turned on. Select '04' on the remote control/central control unit and press up or down. The code is accepted and the number is displayed (red LED flashes four times).

Setting group number on ST-02 controller.

A single **ST-02** controller can control a group of **ST-01** controllers. The group is assigned a number from 1 to 16. The controller number within the group are selected via the central control unit. The number of a group controlled by **ST-02** controller is set on **SW1** switch. The switch position is shown in **ST-02** module diagram.

↑ - switch position **A** - up (ON).

↓ - switch position **B** - down (OFF).

Group	setting	Group	setting	Group	setting	Group	setting
1	↑↑↑↑↑↑↑	5	↑↑↓↑↑↑↑	9	↑↑↑↓↑↑↑	13	↑↑↓↓↑↑↑
2	↓↑↑↑↑↑↑	6	↓↑↓↑↑↑↑	10	↓↑↑↓↑↑↑	14	↓↑↓↓↑↑↑
3	↑↓↑↑↑↑↑	7	↑↓↓↑↑↑↑	11	↑↓↑↓↑↑↑	15	↑↓↓↓↑↑↑
4	↓↓↑↑↑↑↑	8	↓↓↓↑↑↑↑	12	↓↓↑↓↑↑↑	16	↓↓↓↓↑↑↑

Central control unit operation

The central control unit enables:

- direct (keypad) opening and/or closing individual or group of roller shutters,
- opening and/or closing individual and groups of roller shutters at preset time and day.
- remote (remote control) opening and/or closing individual or group of roller shutters with lock function (radio receiver lock),

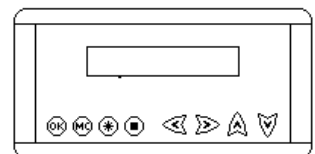

Connecting central control unit.

The central control unit is supplied with 230VAC. The power supply cables are connected to **G4**. Connect a two-conductor cable from **G1** to **ST-01** controller. Connect **G1-2** to **GND** on **ST-01** controller. Connect **G1-1** of **CR-02** central control unit to **WEJ** on **ST-01** controller.

Display and keypad

The central control unit has a two-line (16 character each) LCD and an 8-button keypad. Each button is marked with the following symbols and corresponds to the following functions in different operation modes:

- M/C** (menu) - enter menu, change menu item, exit menu
- OK** (yes) - confirm,
- #** (hash) - remove controllers, enable or disable programs
- (square) - add controllers, enable or disable radio
- ←** (left) - change on-screen cursor position,
- (right) - change on-screen cursor position,
- ▲** (up) - change number or value, direct control (open, close, partially open)
- ▼** (down) - change number or value, direct control (open, close, partially open)

Central control unit operation modes

The following central control unit operation modes are available (press **M/C** to select):

- normal operation mode,
- set open/close parameters of individual or group of roller shutters at preset time,
- define group of roller shutters, set which motors are assigned to each group,
- set current time, date and weekday (clock and calendar),
- register remote controls to control individual or group of roller shutters.
- Partially open roller shutters at preset time

Normal operation mode (stand-by)

The following information is displayed in normal operation mode:

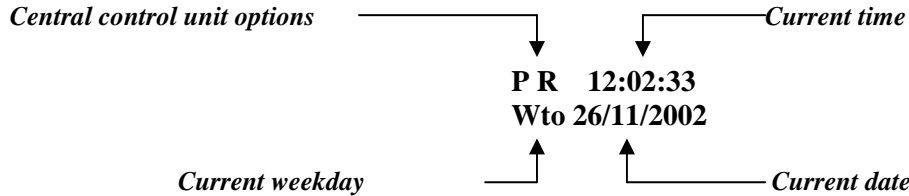

Current date and weekday are displayed in the bottom line. Current time and letters indicating the central control unit operation mode are displayed in the top line. The letter indicates if the corresponding option is enabled or disabled. Option **R** (enabled/disabled with **■**) indicates that the central control unit will respond to remote control commands. If this option is disabled, the central control unit will not respond to remote control commands to protect the system against unauthorised remote access. Option **P** (enabled/disabled with **#**) indicates that individual or group of motors open/close programs at preset time and date are active.

Controlling motors

Open/close, stop and partially open functions for individual or group of motors can be initiated with **▲** or **▼** on the central control unit or the remote control command at preset time. The control command may apply to an individual motor (controller) or a group of motors. The group may include any number of motors (0 to 64) with any number assigned to the group. A delay of approx. 0.5 second between the open/close commands by the central control unit is set and thus the operation for a large group can take approx. 60 seconds. The following information on the action and the motor concerned is displayed instead of the option code when the command is send to the motor. Information:

Otw. xx or **Zam. xx** or **Stop xx** or **Roz.xx** where **xx** is a motor number **01** to **64**.

Controlling motors directly using the central control unit keypad.

Press **▲** or **▼** in the normal operation mode, **Otw. ? (T/M)** or **Zam. ? (T/M)** and **Stop (T/M)** or **Roz. (T/M)** is displayed, respectively. Press **▲** or **▼** to change the operation mode. Press **M/C** to cancel and return to normal operation mode. Press **OK** (yes, confirm) to select individual or group of controllers and determine controller or group number.

The following message is displayed in the top line: **Otw. S01 ? (T/M)** or **Zam. S01 ? (T/M)** or **Stop(T/M)** or **Roz. (T/M)**.

S indicates a single controller. If **S** is underlined, press **▲** or **▼** to change the value **S** to **G** to select the group of controllers. Press **▲** or **▼** to change the value **G** to **S**, and vice versa. Press **➤** to move the cursor from **S** or **G** to the number (second digit, e.g. **01**). Press **▲** or **▼** to change the number of an individual controller (**01** to **64**) or a group of controllers (**01** to **16**). **(T/M)** in the right end of the top line indicates that the operation can be cancelled (press **M/C**) or confirmed (**OK**). A confirmed operation is initiated immediately.

Main menu functions

Press **M/C** in normal operation mode to display other menu items in the bottom line:

- **Programy ? (T/M)** – define timer-controlled automatic open/close programs,
- **Grupy ? (T/M)** – define controller groups,
- **Zegar ? (T/M)** – set current date and time,
- **Piloty ? (T/M)** – register remote controls,
- **Rozszcz?** (T/M) – program partially open function (slight roller shutter opening to let the light into the room)

Press **M/C** to return to normal operation mode or press **OK** to select underlined menu item. The individual main menu items are described below.

Defining timer-controlled automatic open/close programs.

The central control unit allows to define timer-controlled automatic open/close programs for individual controllers or group of controllers. The time is set in hours (from - to) for specific weekdays.

Maximum number of programs available: 32 (01 to 32). Select **Programy ?** to display program 01 definition, e.g.

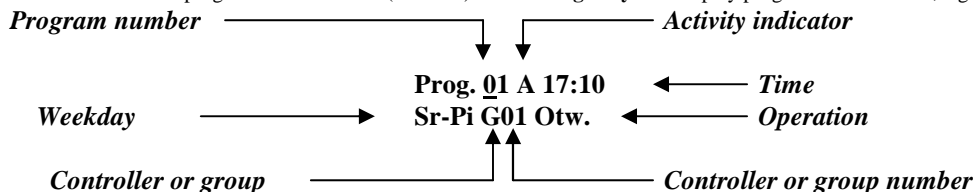

Press **▲** or **▼** will change the displayed program definition of underlined program number (01 to 32). The cursor indicates active (**A**) or inactive (**N**) program. If the program is inactive (**N**), other information (time, date and weekday) are not displayed. Press **◀** or **▶** to change the cursor position to select a field and press **▲** or **▼** to change value. Move cursor and press **▲** or **▼** to change value **A** to **N**, and vice versa. If the program is active (**A**), other values can be changed. Select hour and press **▲** or **▼** to change value (00 to 23). Select minute and press **▲** or **▼** to change value (00 to 55, every 5 minutes). Other values can be changed: weekday, individual controller or a group of controllers, number and selected operation (open/close).

Defining controller groups

A group of controllers operated with a remote control, central control unit keypad or timer-controlled automatic open/close program can be defined in the central control unit. The group may include any number of controllers (0 to 64). Maximum number of groups: 16 (01 to 16). Select **Grupy ?** to display program 01 definition, e.g.

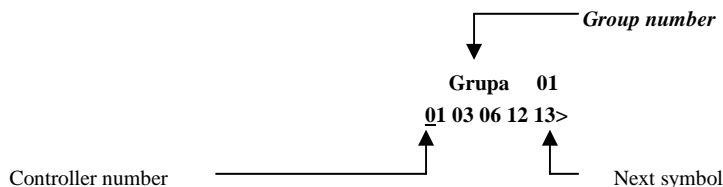

Press \uparrow or \downarrow to change the displayed group definition (01 to 16). The bottom line shows the numbers of controllers in the group (group items). The first item is underlined. Up to 5 items are shown due to the screen size. If the group contains more than 5 items, the first five items are displayed, and the 'next' symbol is shown on the right side (>). Press > to move the cursor (underline) right. After reaching the last item, and if other items are available ('next' symbol shown), press > to show the next item and hide the first item on the list. A 'previous' symbol is shown on the left side (<). The cursor can be moved left (press <). The screen shows up to 5 items. The screen moves right or left, if there are any items available on the left or the right side of the screen (indicated by < and/or > on the left or the right side, respectively) until the end of the line is reached.

The bottom line shows **Pusta !!!** if the group does not contain any items.

Press * (asterisk) to add group item. **Dodaj xx ?** is displayed in the bottom line, where **xx** is the item (controller) number, which will be added to the group. Press **OK** (yes, confirm) to confirm. The number depends on cursor position and items added so far. Only numbers that are not already assigned to the group are available. Press \uparrow or \downarrow to change the number. Press **M/C** to cancel.

Press # (hash) to remove group item. **Usun xx ?** is displayed in the bottom line, where **xx** is the item (controller) number, which will be removed from the group. Press **OK** (yes, confirm) to confirm. Press \uparrow or \downarrow to change the number. The number depends on cursor position. Only numbers that are already assigned to the group are available. Press **M/C** to cancel.

Setting date and time

The internal clock stores its setting even after disconnecting the central control unit power supply. Current time, date and weekday must be set for automatic timer-controlled open/close programs to operate properly. Select **Zegar ?** from the main menu. A request to set time is displayed, e.g.:

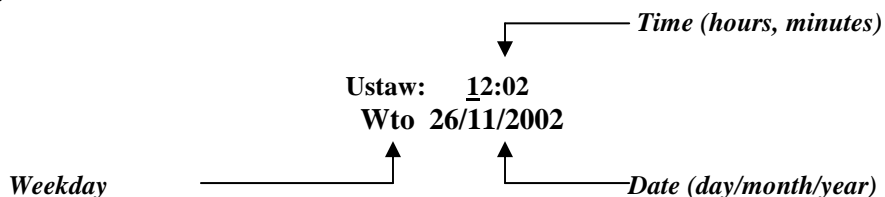

Press \uparrow (up) or \downarrow (down) to change hour, minute, day of the week, day of the month, month or year. The cursor (underline, initially under the hour setting) indicates the value being changed. Set date and time and press **OK** to confirm and return to normal operation mode. Press **M/C** to return to normal operation mode without storing any modifications.

Registering the remote controls

Up to four remote controls (1 to 4) can be registered in the system. Each remote control has a two-digit code on the inner side of the battery cover. The code includes numbers 0 to 9 and letters A to F. Enter the code to register the remote control. No remote control is assigned **00** code, and if entered, no remote control is registered. Select **Piloty ?** to display the remote control codes:

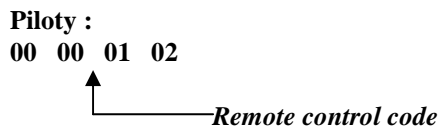

Press < or > to change the remote control code or press \uparrow or \downarrow to move the cursor.

PARTIALLY OPEN FUNCTION

The central control unit allow to define the partially open function for individual roller shutters. Select **Rozszcz.?** from the main menu. The 'partially open' function can be set for all controllers (1 to 64).The time can be set from 0.5 to 8 seconds, every 0.5 second. The display shows numbers 1 to 16 corresponding to: 1 to 0.5 s; 2 to 1s etc. Press < or > to change controller number or move the cursor. Press up \uparrow or down to select. \downarrow

PIL-99 GS REMOTE CONTROL

CAUTION!

The remote control is in stand-by mode to save the battery life. Press

(**OK**), (*****), (**◀**), (**▶**) to activate the remote control. The last selected number is displayed.

Operation mode and changing operation mode.

The remote control can operate in two modes.

Full mode including all controllers (01 to 64) and groups (01 to 16). Simple mode with limited access.

Press **◀** and **▶** simultaneously to change the mode. The selected mode is indicated with a letter **P** - full mode or **S** - simple mode and four digits, where the first two digits are a maximum controller number, and the other two a maximum group number.

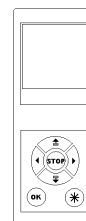

Selecting controller or group number in full mode

Individual controller number (01 to 64) and group number (01 to 16) can be selected in full mode. Procedure:

- Press left button ◀ to change or confirm left digit. Press **up, down** to change value.
- Press right button ▶ to change or confirm right digit. Press **up, down** to change value.
- If no number is changed, up, down and stop buttons will issue open, close or stop command to individual controller or group of controllers.
- Press **OK** to switch between individual controller and group of controllers, the display shows **G** to indicate group. Press **OK** again to exit the group.

Selecting controller or group number in simple mode

- Press left or right button ◀, ▶ to increase or reduce the number of selected controller/group from **01** to **maximum number** set.
- Press **up, down** or **stop** to issue open, close or stop command to the individual controller.
- **Select the maximum number in full mode and switch back to simple mode.**

Adding names to individual motors or groups of motors

Each channel can be assigned a name including up to 16 characters (capital letters or digits) in two lines, 8 characters each. Press **OK** and (✱) simultaneously to enter edit mode. The cursor indicates position that can be changed with **up** or **down**. Press ◀, ▶ to change cursor position. Press **STOP** to delete character. Press **OK** to save changes or press (✱) to cancel.

CAUTION!

After the batteries are replaced, all simple mode settings are lost and must be set again, whereas the controller/group names are stored.

